

Varenummer: 201623B162SW

Beskrivelse: E+G Laskeforbindelse - GN 162.3-B16-2-SW

Mål

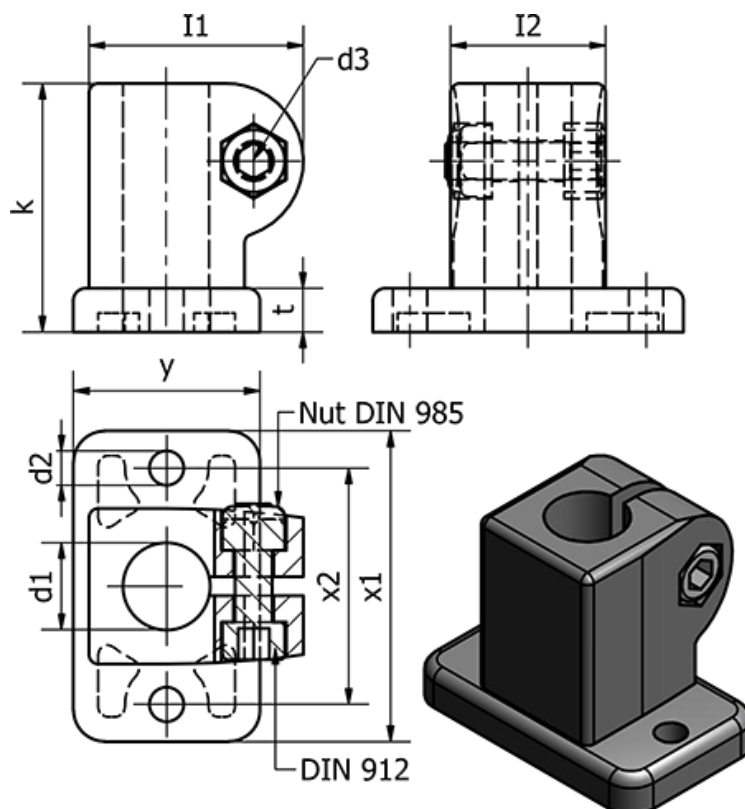

d1	= 16	Vægt (g) = 67
d2	= 5.5	x1 = 50
d3	= M6	x2 = 38
Fastspændings kit for d3	= GN 911-M6-22	y = 30
I1	= 34.5	
I2	= 25	
k	= 40	
t	= 7	